

PROXIMA SYSTEM





Details matter.



FAST WIRING

Flush mounting sockets with pre-wired switch.



EASY TO INSTALL

Slotted and open bottom fixing points and integrated spirit level.



FULL-FLAT DESIGN

Protection from accidental impacts and from dirt and water deposits.



PROXIMA SYSTEM

PROXIMA Series

16A-32A
103x230mm



63A
136x275mm



OPTIMA Series **DOMO Series**



DOMOPLUS Series



PROXIMA System - Components

FLANGE ADAPTORS 103x230mm

100x110mm 70x87mm 50x60mm



573.5001 573.5002 573.5003

PROXIMA System - Components

	SURFACE MOUNTING BOXES				SURFACE MOUNTING MODULAR BASES			SURFACE MOUNTING DISTRIBUTION ASSEMBLIES	
	Single	Single with junction box	Double with junction box	Triple with junction box	Single with consumer unit	Double with consumer unit	Triple with consumer unit	Triple with consumer unit	Quadruple with consumer unit
16A-32A	573.5100	573.5110	573.5120	573.5130	573.5111	573.5121	573.5131		573.5381
63A		573.5210			573.5211				
16A-32A-63A								573.5351	

Combination examples

Surface mounting boxes



Modular bases



Distribution assemblies





PROXIMA Series

PROXIMA is a complete range of interlocked socket outlets from 16 to 63A, with or without fuse protection in 16A and 32A versions.

Available as single surface mounting or flush mounting socket outlets to be installed on the relative modular bases and distribution assemblies system.

Flush mounting versions have the switch pre-wired upstream to speed up the wiring operations of the distribution assemblies.

The large and recessed knob facilitates operation in any condition, while at the same time preventing breakage from accidental impacts.

The socket cover has a clear indication of the open and closed positions and is equipped with a high grip ring nut to ease tightening operations.

 technical sheet p. 18

Technical information

Main characteristics

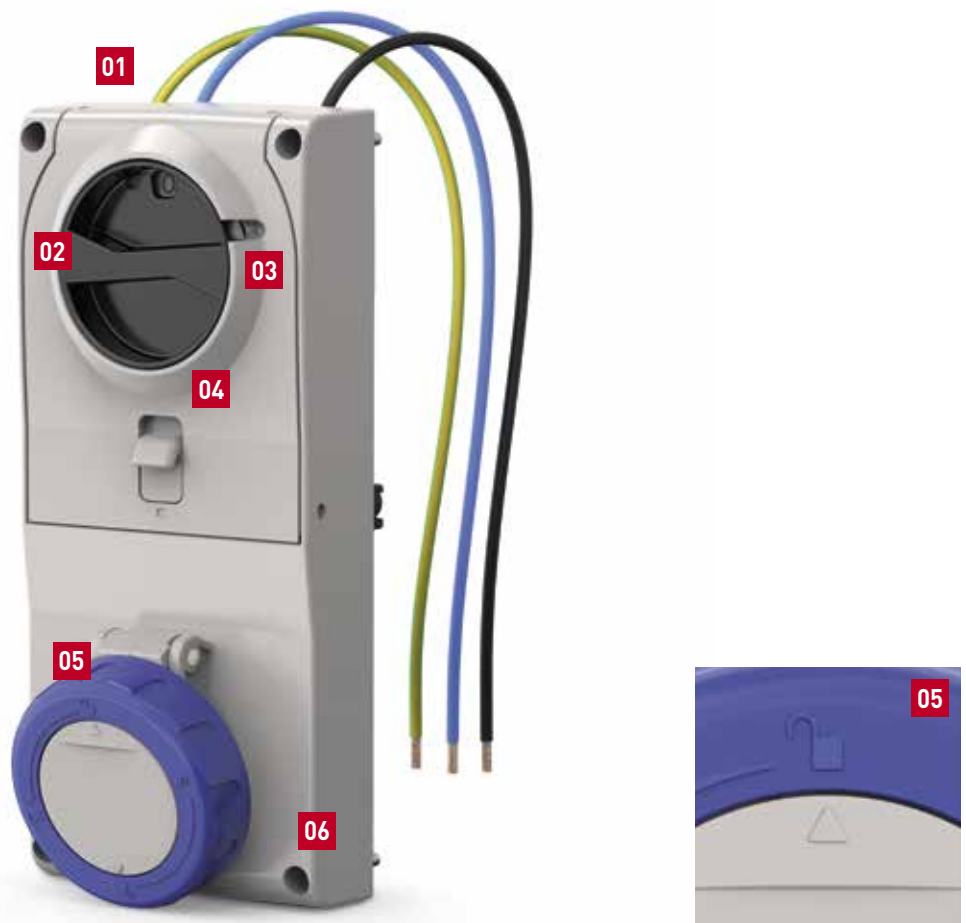

01 Pre-wired switch on DIN rail side (flush mounting versions)

02 XXL handle, ergonomic and recessed to prevent breakage due to accidental impacts

03 Padlockable in the ON and OFF position

04 AC23 switch

05 Clear indication of open or closed position

06 Captive stainless steel closing screws

Application examples



Industry



Terminal container



Food industry



PROXIMA SYSTEM

■ WITHOUT FUSE CARRIER >> FLUSH MOUNTING >> IP66/IP67/IP69



IP: IP66/IP67/IP69
Flange: 103X230MM

Poles	h	Hz	Volt	Colour	16A	1/10	32A	1/10
2P+E	2	>300-500	>50	Green	407.16832 ¹⁾	1/10	407.32832 ¹⁾	1/10
	3	DC	>50-250	Grey	407.16834 ²⁾	1/10	407.32834 ²⁾	1/10
	4	50 60	100-130	Yellow	407.1670	1/10	407.3270	1/10
	6	50 60	200-250	Blue	407.1683	1/10	407.3283	1/10
	7	50 60	480-500	Black	407.16836	1/10	407.32836	1/10
	8	DC	>250	Grey	407.16838 ²⁾	1/10	407.32838 ²⁾	1/10
	9	50 60	380-415	Red	407.1678	1/10	407.3278	1/10
	12	50 60	TST>50	Grey	407.16833	1/10	407.32833	1/10
	3P+E	2	>300-500	>50	Green	407.16862 ¹⁾	1/10	407.32862 ¹⁾
3		50 60	380 50Hz / 440 60Hz	Red	407.16864	1/10	407.32864	1/10
4		50 60	100-130	Yellow	407.1672	1/10	407.3272	1/10
5		50 60	600-690	Black	407.16867 ³⁾	1/10	407.32867 ³⁾	1/10
6		50 60	380-415	Red	407.1686	1/10	407.3286	1/10
7		50 60	480-500	Black	407.16866	1/10	407.32866	1/10
9		50 60	200-250	Blue	407.1674	1/10	407.3274	1/10
10		100-300	>50	Green	407.16861 ¹⁾	1/10	407.32861 ¹⁾	1/10
11		60	440-460	Red	407.16865	1/10	407.32865	1/10
3P+N+E	2	>300-500	>50	Green	407.16872 ¹⁾	1/10	407.32872 ¹⁾	1/10
	3	50 60	380 50Hz / 440 60Hz	Red	407.16874	1/10	407.32874	1/10
	4	50 60	100-130	Yellow	407.1679	1/10	407.3279	1/10
	5	50 60	600-690	Black	407.16877 ³⁾	1/10	407.32877 ³⁾	1/10
	6	50 60	346-415	Red	407.1687	1/10	407.3287	1/10
	7	50 60	480-500	Black	407.16876	1/10	407.32876	1/10
	9	50 60	208-250	Blue	407.1675	1/10	407.3275	1/10
	11	60	440-460	Red	407.16875	1/10	407.32875	1/10



IP: IP66/IP67/IP69
Flange: 136X275MM

Poles	h	Hz	Volt	Colour	63A	1/6
2P+E	2	>300-500	>50	Green	407.63832 ¹⁾	1/6
	3	DC	>50-250	Grey	407.63834 ²⁾	1/6
	4	50 60	100-130	Yellow	407.6370	1/6
	6	50 60	200-250	Blue	407.6383	1/6
	7	50 60	480-500	Black	407.63836	1/6
	9	50 60	380-415	Red	407.6378	1/6
	12	50 60	TST>50	Grey	407.63833	1/6
	2	>300-500	>50	Green	407.63862 ¹⁾	1/6
	3	50 60	380 50Hz / 440 60Hz	Red	407.63864	1/6
3P+E	4	50 60	100-130	Yellow	407.6372	1/6
	5	50 60	600-690	Black	407.63867 ³⁾	1/6
	6	50 60	380-415	Red	407.6386	1/6
	7	50 60	480-500	Black	407.63866	1/6
	9	50 60	200-250	Blue	407.6374	1/6
	10	100-300	>50	Green	407.63861 ¹⁾	1/6
	11	60	440-460	Red	407.63865	1/6
	2	>300-500	>50	Green	407.63872 ¹⁾	1/6
	3	50 60	380 50Hz / 440 60Hz	Red	407.63874	1/6
3P+N+E	4	50 60	100-130	Yellow	407.6379	1/6
	5	50 60	600-690	Black	407.63877 ³⁾	1/6
	6	50 60	346-415	Red	407.6387	1/6
	7	50 60	480-500	Black	407.63876	1/6
	9	50 60	208-250	Blue	407.6375	1/6
	11	60	440-460	Red	407.63875	1/6

Supplied with stainless steel fixing screws.
Pre-wired connection cables provided.

¹⁾ The maximum amount of current available, taking into account the maximum overheating temperature allowed by the relevant standards, must be downgraded with respect to the nominal current by 25% for products with frequencies ranging above 100 Hz; contact Scame Technical Service for further information.

²⁾ When using DC we recommend that you make sure of implementing the protection scheme that is most suitable for the system involved; contact Scame Technical Service for further information.

³⁾ Pay special attention when selecting the appropriate fuse with respect to the tension of the installation.

■ WITHOUT FUSE CARRIER >> SURFACE MOUNTING >> IP66/IP67/IP69



IP: IP66/IP67/IP69

Poles	h	Hz	Volt	Colour	16A		32A	
2P+E	2	>300-500	>50		507.16832 ¹⁾	1/10	507.32832 ¹⁾	1/10
	3	DC	>50-250		507.16834 ²⁾	1/10	507.32834 ²⁾	1/10
	4	50 60	100-130		507.1670	1/10	507.3270	1/10
	6	50 60	200-250		507.1683	1/10	507.3283	1/10
	7	50 60	480-500		507.16836	1/10	507.32836	1/10
	8	DC	>250		507.16838 ²⁾	1/10	507.32838 ²⁾	1/10
	9	50 60	380-415		507.1678	1/10	507.3278	1/10
	12	50 60	TST>50		507.16833	1/10	507.32833	1/10
3P+E	2	>300-500	>50		507.16862 ¹⁾	1/10	507.32862 ¹⁾	1/10
	3	50 60	380 50Hz / 440 60Hz		507.16864	1/10	507.32864	1/10
	4	50 60	100-130		507.1672	1/10	507.3272	1/10
	5	50 60	600-690		507.16867 ³⁾	1/10	507.32867 ³⁾	1/10
	6	50 60	380-415		507.1686	1/10	507.3286	1/10
	7	50 60	480-500		507.16866	1/10	507.32866	1/10
	9	50 60	200-250		507.1674	1/10	507.3274	1/10
	10	100-300	>50		507.16861 ¹⁾	1/10	507.32861 ¹⁾	1/10
11	60	440-460		507.16865	1/10	507.32865	1/10	
3P+N+E	2	>300-500	>50		507.16872 ¹⁾	1/10	507.32872 ¹⁾	1/10
	3	50 60	380 50Hz / 440 60Hz		507.16874	1/10	507.32874	1/10
	4	50 60	100-130		507.1679	1/10	507.3279	1/10
	5	50 60	600-690		507.16877 ³⁾	1/10	507.32877 ³⁾	1/10
	6	50 60	346-415		507.1687	1/10	507.3287	1/10
	7	50 60	480-500		507.16876	1/10	507.32876	1/10
	9	50 60	208-250		507.1675	1/10	507.3275	1/10
	11	60	440-460		507.16875	1/10	507.32875	1/10

Blank side with drilling point marks.
Top and bottom side cable entry.

¹⁾ The maximum amount of current available, taking into account the maximum overheating temperature allowed by the relevant standards, must be downgraded with respect to the nominal current by 25% for products with frequencies ranging above 100 Hz; contact Scame Technical Service for further information.

²⁾ When using DC we recommend that you make sure of implementing the protection scheme that is most suitable for the system involved; contact Scame Technical Service for further information.

³⁾ Pay special attention when selecting the appropriate fuse with respect to the tension of the installation.

PROXIMA SYSTEM

■ WITH FUSE CARRIER >> FLUSH MOUNTING >> IP66/IP67/IP69



IP: IP66/IP67/IP69
Flange: 103X230MM

Poles	h	Hz	Volt	Colour	16A	1/10	32A	1/10
2P+E	2	>300-500	>50	Green	408.16832 ¹⁾	1/10	408.32832 ¹⁾	1/10
	3	DC	>50-250	Grey	408.16834 ²⁾	1/10	408.32834 ²⁾	1/10
	4	50 60	100-130	Yellow	408.1670	1/10	408.3270	1/10
	6	50 60	200-250	Blue	408.1683	1/10	408.3283	1/10
	7	50 60	480-500	Black	408.16836	1/10	408.32836	1/10
	8	DC	>250	Grey	408.16838 ²⁾	1/10	408.32838 ²⁾	1/10
	9	50 60	380-415	Red	408.1678	1/10	408.3278	1/10
	12	50 60	TST>50	Grey	408.16833	1/10	408.32833	1/10
	3P+E	2	>300-500	>50	Green	408.16862 ¹⁾	1/10	408.32862 ¹⁾
3		50 60	380 50Hz / 440 60Hz	Red	408.16864	1/10	408.32864	1/10
4		50 60	100-130	Yellow	408.1672	1/10	408.3272	1/10
5		50 60	600-690	Black	408.16867 ³⁾	1/10	408.32867 ³⁾	1/10
6		50 60	380-415	Red	408.1686	1/10	408.3286	1/10
7		50 60	480-500	Black	408.16866	1/10	408.32866	1/10
9		50 60	200-250	Blue	408.1674	1/10	408.3274	1/10
10		100-300	>50	Green	408.16861 ¹⁾	1/10	408.32861 ¹⁾	1/10
11		60	440-460	Red	408.16865	1/10	408.32865	1/10
3P+N+E	2	>300-500	>50	Green	408.16872 ¹⁾	1/10	408.32872 ¹⁾	1/10
	3	50 60	380 50Hz / 440 60Hz	Red	408.16874	1/10	408.32874	1/10
	4	50 60	100-130	Yellow	408.1679	1/10	408.3279	1/10
	5	50 60	600-690	Black	408.16877 ³⁾	1/10	408.32877 ³⁾	1/10
	6	50 60	346-415	Red	408.1687	1/10	408.3287	1/10
	7	50 60	480-500	Black	408.16876	1/10	408.32876	1/10
	9	50 60	208-250	Blue	408.1675	1/10	408.3275	1/10
11	60	440-460	Red	408.16875	1/10	408.32875	1/10	

Supplied with stainless steel fixing screws.
Pre-wired connection cables provided.

¹⁾ The maximum amount of current available, taking into account the maximum overheating temperature allowed by the relevant standards, must be downgraded with respect to the nominal current by 25% for products with frequencies ranging above 100 Hz; contact Scame Technical Service for further information.

²⁾ When using DC we recommend that you make sure of implementing the protection scheme that is most suitable for the system involved; contact Scame Technical Service for further information.

³⁾ Pay special attention when selecting the appropriate fuse with respect to the tension of the installation.

■ WITH FUSE CARRIER >> SURFACE MOUNTING >> IP66/IP67/IP69



IP: IP66/IP67/IP69

Poles	h	Hz	Volt	Colour	16A		32A	
2P+E	2	>300-500	>50		508.16832 ¹⁾	1/10	508.32832 ¹⁾	1/10
	3	DC	>50-250		508.16834 ²⁾	1/10	508.32834 ²⁾	1/10
	4	50 60	100-130		508.1670	1/10	508.3270	1/10
	6	50 60	200-250		508.1683	1/10	508.3283	1/10
	7	50 60	480-500		508.16836	1/10	508.32836	1/10
	8	DC	>250		508.16838 ²⁾	1/10	508.32838 ²⁾	1/10
	9	50 60	380-415		508.1678	1/10	508.3278	1/10
	12	50 60	TST>50		508.16833	1/10	508.32833	1/10
3P+E	2	>300-500	>50		508.16862 ¹⁾	1/10	508.32862 ¹⁾	1/10
	3	50 60	380 50Hz / 440 60Hz		508.16864	1/10	508.32864	1/10
	4	50 60	100-130		508.1672	1/10	508.3272	1/10
	5	50 60	600-690		508.16867 ³⁾	1/10	508.32867 ³⁾	1/10
	6	50 60	380-415		508.1686	1/10	508.3286	1/10
	7	50 60	480-500		508.16866	1/10	508.32866	1/10
	9	50 60	200-250		508.1674	1/10	508.3274	1/10
	10	100-300	>50		508.16861 ¹⁾	1/10	508.32861 ¹⁾	1/10
11	60	440-460		508.16865	1/10	508.32865	1/10	
3P+N+E	2	>300-500	>50		508.16872 ¹⁾	1/10	508.32872 ¹⁾	1/10
	3	50 60	380 50Hz / 440 60Hz		508.16874	1/10	508.32874	1/10
	4	50 60	100-130		508.1679	1/10	508.3279	1/10
	5	50 60	600-690		508.16877 ³⁾	1/10	508.32877 ³⁾	1/10
	6	50 60	346-415		508.1687	1/10	508.3287	1/10
	7	50 60	480-500		508.16876	1/10	508.32876	1/10
	9	50 60	208-250		508.1675	1/10	508.3275	1/10
	11	60	440-460		508.16875	1/10	508.32875	1/10

Blank side with drilling point marks.
Top and bottom side cable entry.

¹⁾ The maximum amount of current available, taking into account the maximum overheating temperature allowed by the relevant standards, must be downgraded with respect to the nominal current by 25% for products with frequencies ranging above 100 Hz; contact Scame Technical Service for further information.

²⁾ When using DC we recommend that you make sure of implementing the protection scheme that is most suitable for the system involved; contact Scame Technical Service for further information.

³⁾ Pay special attention when selecting the appropriate fuse with respect to the tension of the installation.

PROXIMA SYSTEM

■ EXTRA LOW VOLTAGE <50V >> FLUSH MOUNTING >> WITH SAFETY TRANSFORMER - IP66/IP67/IP69



Poles	Hz	Volt	Colour	16A	
2P	50 60	24		407.2416	1/10

Supplied with stainless steel fixing screws.
Pre-wired connection cables provided.

With electrical block switch that operates on the transformer primary or that, if duly connected, can activate relays and contactors.

SELV transformer 220/24V- 150VA (continuous duty).

Provided protections: primary circuit (2A), secondary circuit (6A), fuses included.

IP: IP66/IP67/IP69
Flange: 103X230MM

■ EXTRA LOW VOLTAGE <50V >> FLUSH MOUNTING >> WITHOUT SAFETY TRANSFORMER - IP66/IP67/IP69



Poles	h	Hz	Volt	Colour	16A		32A	
2P		50 60	20-25		407.2420		407.2620	1/10
	12	50 60	40-50		407.2421		407.2621	1/10

Supplied with stainless steel fixing screws.

Pre-wired connection cables provided.

With electrical block switch that operates on the transformer primary or that, if duly connected, can activate relays and contactors.

IP: IP66/IP67/IP69
Flange: 103X230MM

Application examples



■ KIT >> KIT MICRO-SWITCH







Description	Notes	Code	
MICROSWITCH KIT	16/32A NC	654.0392	10
	16/32A NO	654.0391	10
	63/125A NC	654.0394	10
	63/125A NO	654.0393	10

Suited for flush mounting angled outlet versions only.
For inserted plug detection.

■ ACCESSORIES FOR ENCLOSURES >> AUXILIARY CONTACTS



Description	Colour	Switch size	Code	
NC CONTACT		16A-32A	590.PL004001 ¹⁾	10/60
		63A	590.PL004003 ¹⁾	10
NO CONTACT		16A-32A	590.PL004002 ²⁾	10/60
		63A	590.PL004004 ²⁾	10

Snap catch.

¹⁾NC=Normally closed.

²⁾NO=Normally open.



Components

Series of enclosures for wall installation of single sockets or distribution assemblies in configurations from 1 to 4 sockets, with junction box or consumer unit.

The flat profiled door of the consumer unit has the particularity of the concealed opening system, which can be equipped on request with a yale key.

The lower fixing points with open slot and the metal bracket integrated in the rear part of the modular bases simplify the wall installation operations.

The drilling point marks centers give maximum flexibility at the installation level.

 technical sheet p. 22

Technical information

Main characteristics



01 Pressure window closing system (Yale key on request)

02 Slotted lower fixing points to facilitate wall fixing operations

03 Integrated external fixing points

04 Metal bracket to facilitate wall fixing during installation procedure

05 Blank sides with drilling point marks

06 Full flat window to prevent dirt and dust deposit

■ COMPONENTS FOR SURFACE MOUNTING INSTALLATION



Description	IP	Dimensions	Flange	Notes	Code	
SURFACE MOUNTING BOX	IP66/IP67/IP69	107X259X79MM	103X230MM	1x16A-32A	573.5100	1/5

■ COMPONENTS FOR SURFACE MOUNTING INSTALLATION >> 1 PROXIMA + JUNCTION BOX



Description	IP	Dimensions	Notes	Code	
MODULAR BASE	IP66	107X438X110MM	1x16A-32A	573.5110	1
		140X485X110MM	1x63A	573.5210	1

■ COMPONENTS FOR SURFACE MOUNTING INSTALLATION >> 2 PROXIMA + JUNCTION BOX



Description	IP	Dimensions	Notes	Code	
MODULAR BASE	IP66	212X438X110MM	2x16A-32A	573.5120	1

■ COMPONENTS FOR SURFACE MOUNTING INSTALLATION >> 3 PROXIMA + JUNCTION BOX



Description	IP	Dimensions	Notes	Code	
MODULAR BASE	IP66	317X438X110MM	3x16A-32A	573.5130	1



COMPONENTS FOR SURFACE MOUNTING INSTALLATION >> 1 PROXIMA + CONSUMER UNIT



Description	IP	Dimensions	Notes	Code	
MODULAR BASE	IP65	107X438X110MM	1x16A-32A + 5 DIN	573.5111	1
		140X485X110MM	1x63A + 7 DIN	573.5211	1

COMPONENTS FOR SURFACE MOUNTING INSTALLATION >> 2 PROXIMA + CONSUMER UNIT



Description	IP	Dimensions	Notes	Code	
MODULAR BASE	IP65	212X438X110MM	2x16A-32A + 10 DIN	573.5121	1

COMPONENTS FOR SURFACE MOUNTING INSTALLATION >> 3 PROXIMA + CONSUMER UNIT



Description	IP	Dimensions	Notes	Code	
MODULAR BASE	IP65	317X438X110MM	3x16A-32A + 16 DIN	573.5131	1



Description	IP	Dimensions	Notes	Code	
DISTRIBUTION ASSEMBLY	IP65	477X550X156MM	2x16A-32A 1x63A + 24DIN	573.5351	1

Lower positioned cut-outs to contain 16A (70x87mm) or, with suitable adaption, 32A socket (84x106mm) and DOMOPLUS Series.

COMPONENTS FOR SURFACE MOUNTING INSTALLATION >> 4 PROXIMA + CONSUMER UNIT



Description	IP	Dimensions	Notes	Code	
DISTRIBUTION ASSEMBLY	IP65	477X550X156MM	4x16A-32A + 24DIN	573.5381	1

Lower positioned cut-outs to contain 16A (70x87mm) or, with suitable adaption, 32A socket (84x106mm) and DOMOPLUS Series.

COMPONENTS FOR SURFACE MOUNTING INSTALLATION - FLANGE ADAPTER



Description	IP	Flange	Notes	Code	
FLANGE ADAPTER	IP65	103X230MM	1x63A[100x110mm]	573.5001	1/5
		103X230MM	2x16A[70x87mm]	573.5002¹⁾	1/5
		103X230MM	3xDOMO[50x60mm]	573.5003	1/5

¹⁾ Lower positioned cut-outs to contain 16A (70x87mm) or, with suitable adaption, 32A socket (84x106mm) and DOMOPLUS Series.

COMPONENTS FOR SURFACE MOUNTING INSTALLATION - BLANK COVER



Description	IP	Flange	Notes	Code	
BLANK COVER	IP65	103X230MM	BLANK	573.5000	1/5

ACCESSORIES >> BLANK PLATES



Description	IP	Flange	Notes	Code	
BLANK PLATE FOR PANEL CUT OUTS		70x87MM	BLANK	654.0100P	1/5
		50x60MM	BLANK	654.0105P	1/5

ACCESSORIES >> BLANK PLATES FOR DIN MODULES



Description	Notes	No. modules	Code	
SPACERS	9x45mm	1/2 MOD.	654.0420¹⁾	25/400
	18x45mm	1 MOD.	654.0410¹⁾	25/250
BLANK PLATE FOR DIN MODULES	73x49mm	4 MOD.	654.0400	25

When put between the modular devices these plates help to dissipate heat.

¹⁾ To be fixed on DIN rail.

ACCESSORIES >> CONNECTION KIT



Description	Notes	Code	
CONNECTION KIT	PG21	654.0038	25

ACCESSORIES >> YALE KEY KIT



Description	Code	
YALE KEY KIT	654.0075	1/10

PROXIMA SYSTEM

INDUSTRIAL SWITCHED INTELOCKED SOCKET OUTLETS >50V





REFERENCE STANDARDS

IEC EN 60309-1
IEC EN 60309-2
IEC EN 60309-4

MARKINGS AND DIRECTIVES



VERSIONS

	Surface mounting without fuse carrier
	Surface mounting with fuse carrier
	Flush mounting without fuse carrier
	Flush mounting with fuse carrier

TECHNICAL CHARACTERISTICS

Rated current:	16A-32A-63A
Rated voltage:	>50÷690V
Frequency:	50/60Hz – 60Hz – 100-300Hz - >300 – 500Hz – DC
Insulating voltage:	2P+E 500V 3P+E / 3P+N+E 690V
Protection degree:	IP66/IP67/IP69
Installation temperature:	-25°C +60°C
Enclosure material:	Thermoplastic (Halogen Free)
Colour:	Grey RAL7004
Self extinguishing degree (GWT):	650°C (body) 850°C (socket contact carrier) 960°C (switch)
Impact resistance (IK degree):	16A-32A IK10 63A IK09
Fuses:	16A-32A gG 10,3x38mm
Insulation class:	Class II (double insulation) □
Auxiliary contacts:	Max 2 auxiliary contacts
Handle lock (with padlock):	OFF and ON
Padlock arch diameter to be used:	16A-32A 5mm 63A 6mm

BEHAVIOUR WITH CHEMICAL AND ATMOSPHERIC AGENTS

Saline solution	Acids		Bases		Solvents				Mineral oil	UV rays
	Concentrated	Diluted	Concentrated	Diluted	Hexane	Benzol	Acetone	Alcohol		
Resistant	Limited resistance	Resistant	Limited resistance	Resistant	Limited resistance	Not resistant	Not resistant	Limited resistance	Limited resistance	Resistant

Resistance values to chemical agents have to be considered indicative. For further information and specific substances, contact the technical service.

■ SWITCH-DISCONNECTOR TECHNICAL CHARACTERISTICS

Switch size			Y1		Y2		
Switched interlocked socket outlet rated current			16A	32A	63A		
Conventional enclosed thermal current I_{the}			A	16	32	63	
Rated operational current according to utilization category I_e	AC21A	Resistive loads, including moderate overloads	415V	A	16	32	63
			500V	A	16	32	63
			690V	A	16	32	63
	AC22A	Mixed resistive and inductive loads, including moderate overloads	415V	A	16	32	63
			500V	A	16	32	63
			690V	A	16	32	63
	AC23A	Switching of motor loads or other highly inductive loads (3 phase/3 pole)	415V	A	16	32	63
			500V	A	16	32	40
			690V	A	16	25	30
	AC3	Squirrel-cage motor: starting, switching off motor during running (3 phase /3 poles)	400V	A	16	28.5	40
			600V	A	12	20	25
	DC22A ¹⁾	Mixed resistive and inductive loads, including moderate overloads	250V	A	16	32	63
600V			A	10	10	-	
Rated operational power according to utilization category at 415V	AC23A ²⁾	Switching of motor loads or other highly inductive loads (3 phase/3 pole)	415V	kW	7.5	15	33

For further technical information on the switches, refer to the characteristics of the COMMAND and ISOLATORS series.

¹⁾ 4P versions with poles in series.

²⁾ This value is provided as an indication considering the most critical inductive load condition and may vary according to the specifications provided by the motor manufacturer.

■ CABLING CAPACITY OF THE ENTRY TERMINALS (SWITCH)

Rated current		16A	32A	63A	
Cross-section of the connectable conductors	mm	Min	1.5	1.5	6
		Max	10	10	35
Tightening torque	Nm	0.8	0.8	3.6	

■ CABLE ENTRIES

16A-32A		63A	
Top	Bottom	Top	Bottom
Blank side max 1xM32	Blank side max 1xM32	Blank side max 1xM40	Blank side max 1xM32

Blank sides with drilling point marks.



PROXIMA SYSTEM

INDUSTRIAL SWITCHED INTELOCKED SOCKET OUTLETS <50V



REFERENCE STANDARDS

IEC EN 60309-1

IEC EN 60309-2

IEC EN 60309-4

MARKINGS AND DIRECTIVES



VERSIONS



With SELV transformer
230/24V~ 150VA



Without transformer

TECHNICAL CHARACTERISTICS

Rated current:	16A-32A
Rated voltage:	20V-25V, 40V-50V, 24V with transformer (16A)
Frequency:	50/60Hz
Insulating voltage:	50V
Potenza trasformatore ¹⁾ :	150VA
Protection degree:	IP66/IP67/IP69
Installation temperature:	-25°C +60°C
Enclosure material:	Thermoplastic (Halogen Free)
Colour:	Grey RAL7004
Self extinguishing degree (GWT):	650°C (Body) 850°C (Socket contact carrier)
Impact resistance (IK degree):	IK10
Insulation class:	Class III ⚡ (SELV protections)

¹⁾Version with transformer only.

BEHAVIOUR WITH CHEMICAL AND ATMOSPHERIC AGENTS

Saline solution	Acids		Bases		Solvents				Mineral oil	UV rays
	Concentrated	Diluted	Concentrated	Diluted	Hexane	Benzol	Acetone	Alcohol		
Resistant	Limited resistance	Resistant	Limited resistance	Resistant	Limited resistance	Not resistant	Not resistant	Limited resistance	Limited resistance	Resistant

Resistance values to chemical agents have to be considered indicative. For further information and specific substances, contact the technical service.

■ CABLING CAPACITY OF THE ENTRY TERMINALS

Rated current			16A with transformer	16A without transformer	32A without transformer
Cross-section of the connectable conductors	mm	Min	1	4	4
		Max	4	16	16
Tightening torque	Nm		0.6	1.2	1.2

■ CABLE ENTRIES

16A-32A		63A	
Top	Bottom	Top	Bottom
Blank side max 1xM32	Blank side max 1xM32	Blank side max 1xM40	Blank side max 1xM32

Blank sides with drilling point marks.

■ PROTECTIONS FOR THE VERSION WITH TRANSFORMER

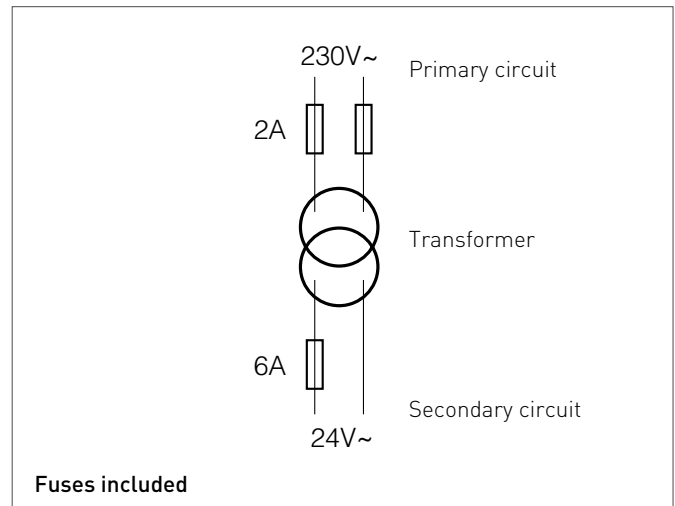

PROXIMA SYSTEM - COMPONENTS

MODULAR ENCLOSURES AND INSTALLATION ACCESORIES



REFERENCE STANDARDS

IEC EN 60670-1

IEC EN 60670-24

MARKINGS AND DIRECTIVES



VERSIONS



Boxes



Flange adaptors



Modular bases



Distribution assemblies

TECHNICAL CHARACTERISTICS

Protection degree:	IP65 (versions with consumer unit) IP66 (versions with junction box)
Installation temperature:	-25°C +60°C
Enclosure material:	Thermoplastic (Halogen Free)
Colour:	Grey RAL7004
Self extinguishing degree (GWT):	650°C
Impact resistance (IK degree):	IK10 (boxes) IK08 (modular bases and distribution assemblies)
Insulation class:	Class II (double insulation) □
Compatibility:	PROXIMA Series 16A-32A-63A
DIN modules (consumer unit versions):	1 socket outlet 16A-32A 5 modules 1 socket outlet 63A 7 modules 2 socket outlets 16A-32A 10 modules 3 socket outlets 16A-32A 16 modules
DIN modules (distribution assemblies):	24 modules

BEHAVIOUR WITH CHEMICAL AND ATMOSPHERIC AGENTS

Saline solution	Acids		Bases		Solvents				Mineral oil	UV rays
	Concentrated	Diluted	Concentrated	Diluted	Hexane	Benzol	Acetone	Alcohol		
Resistant	Limited resistance	Resistant	Limited resistance	Resistant	Limited resistance	Not resistant	Not resistant	Limited resistance	Limited resistance	Resistant

Resistance values to chemical agents have to be considered indicative. For further information and specific substances, contact the technical service.

■ CABLE ENTRIES

Boxes		
Top	Bottom	Side
Blank sides with drilling point marks max M32 (16A-32A) max M40 (63A)	Blank sides with drilling point marks max M32 (16A-32A) max M32 (63A)	Black sides

Modular bases		
Top	Bottom	Side
Blank sides with drilling point marks max M32	Blank sides with drilling point marks max M32	Black sides

Distribution assemblies		
Top	Bottom	Side
Blank sides with drilling point marks max M40	Blank sides with drilling point marks max M40	Blank sides with drilling point marks max M32



ZP01170-EN-1
8 001636 416434



SCAME PARRE S.p.A.
Via Costa Erta, 15 - 24020 Parre (BG) Italy
Tel. +39 035 705000 - Fax +39 035 703122



www.scame.com
export@scame.com

